

Article

FA 054 DR

Technical data sheet



Object:

Parameters bottom \varnothing 54DR

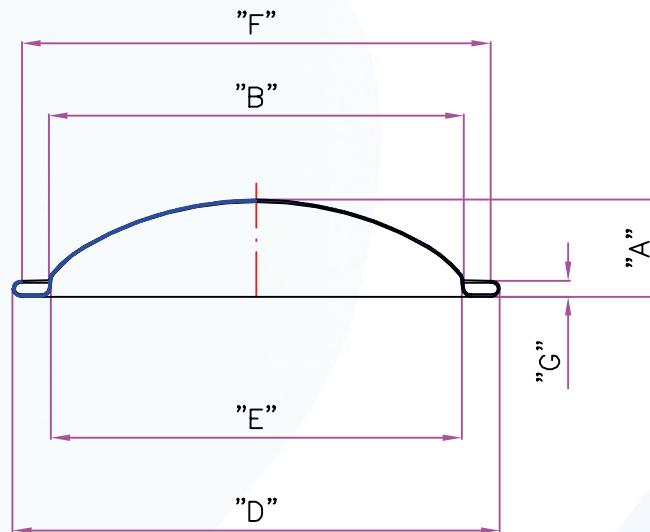

This drawing
is Cabagaglio's property.
Its reproduction
is forbidden by law.



Unit of
measurement:
mm

Dimensions	Theoretical measures	Control tolerances
A	12.83	± 0.25
B	54.95	± 0.1
D	64.44	± 0.2
E	54.15	± 0.1
F	62.00	MIN
G	2.12	± 0.2

Cabagaglio S.p.a.

Via Dell'Industria, 17 | 23844 Sirone (LC) – Italy
Tel.: +39 0341 494350 | Fax: +39 0341 494584
E-Mail: sales@cabagaglio.it | Web: www.cabagaglio.it
P.Iva 01548350139

Cabagaglio
S.p.a.